

Date	rev.	Description
------	------	-------------

House	P5030-44	August
-------	----------	--------

Drawing	3D	Scale
---------	----	-------

Material	44x135	Date	12.02.2016
----------	--------	------	------------

Drawer	RP	File	P5030-44_August_3D.dwg
--------	----	------	------------------------

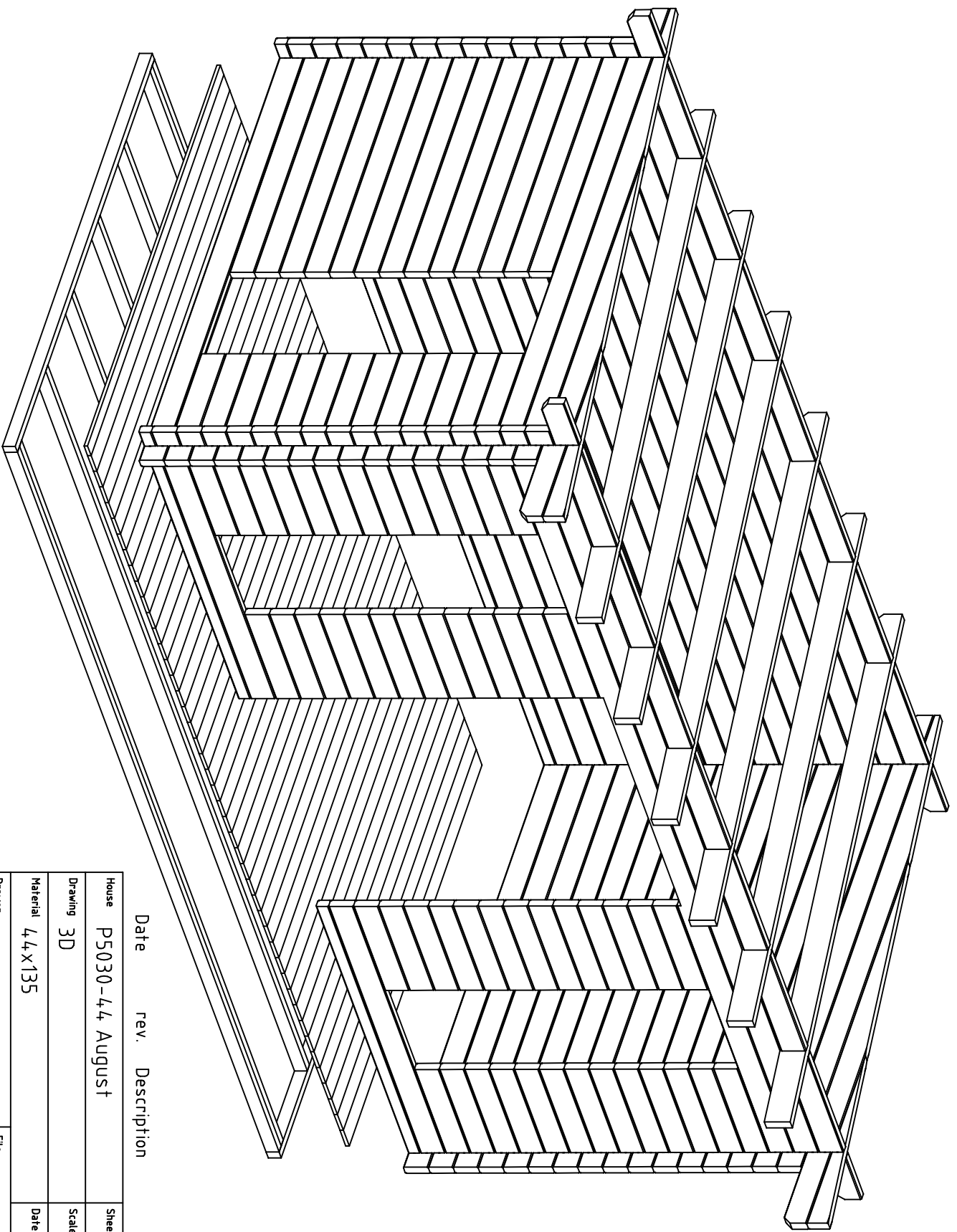

Date rev. Description

House	P5030-44 August	Sheet	2
Drawing	3D	Scale	
Material	4.4x135	Date	12.02.2016
Drawer	RP	File	P5030-44 August 3D.dwg

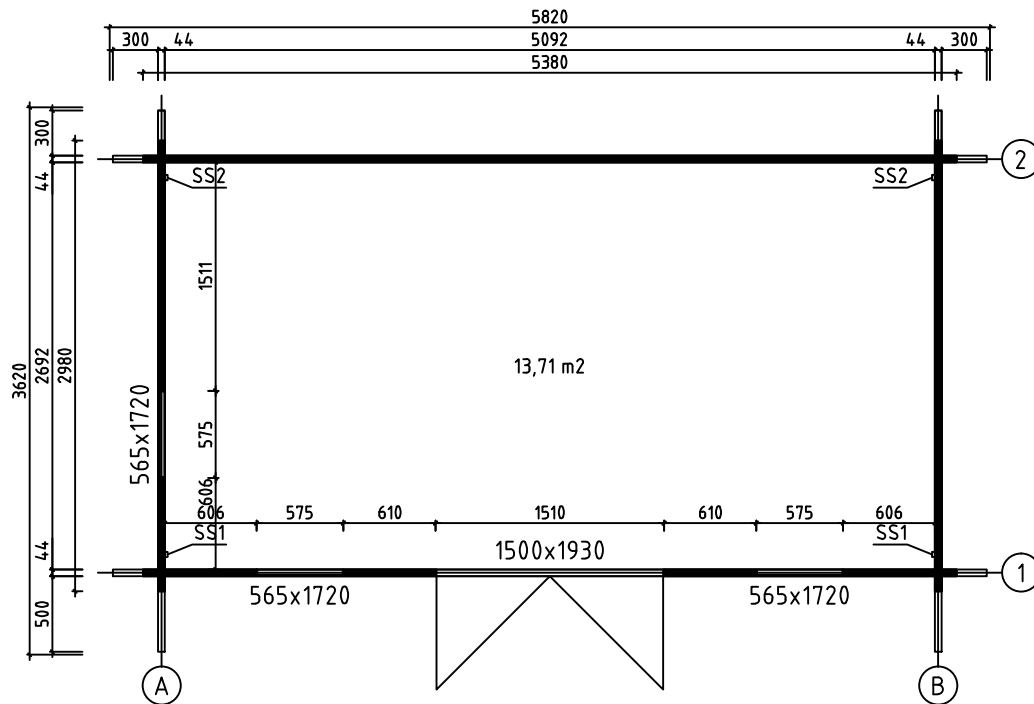

House	P5030-44 August	Sheet	3
Drawing	PLAN-SUUNNITELMA-PLANEN	Scale	1:50
Material	44x135	Date	12.02.2016
Drawer	RP	File	P5030-44 August.dwg

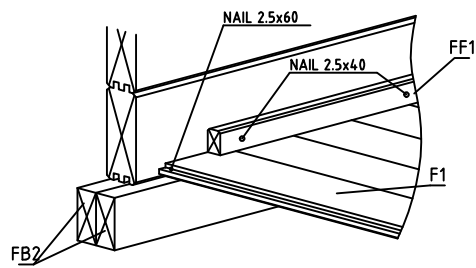
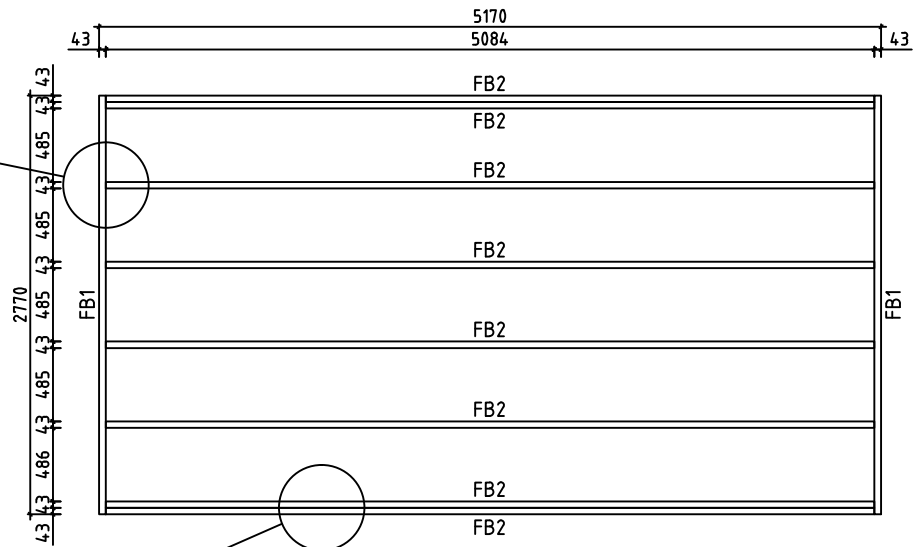
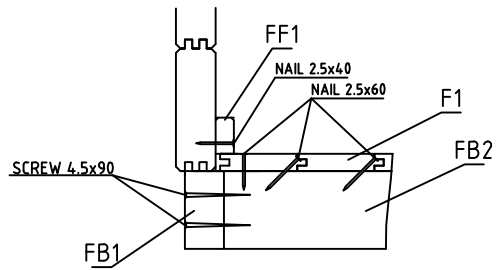

House	P5030-44 August	Sheet	4
Drawing	FLOORBEAMS-LATTIAPALKIT-GOLVBJÄLKAR	Scale	1:50
Material	43x70	Date	12.02.2016
Drawer	RP	File	P5030-44 August.dwg

F1

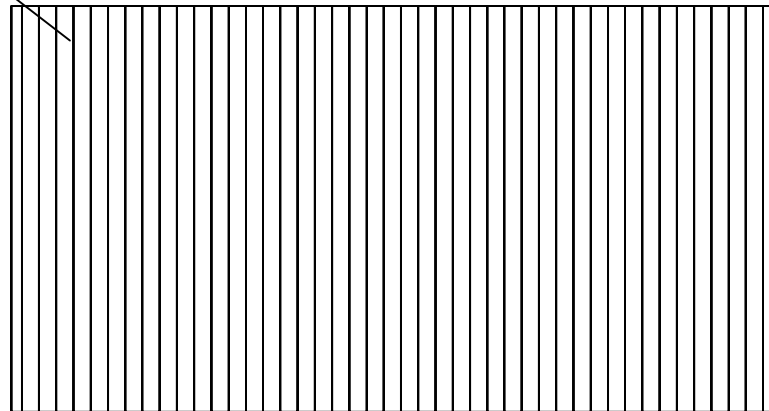

House	P5030-44 August	Sheet	5
Drawing	FLOORBOARD-LATTIALAUTA-GOLVBRÄDE	Scale	1:50
Material	114x19	Date	12.02.2016
Drawer	RP	File	P5030-44 August.dwg

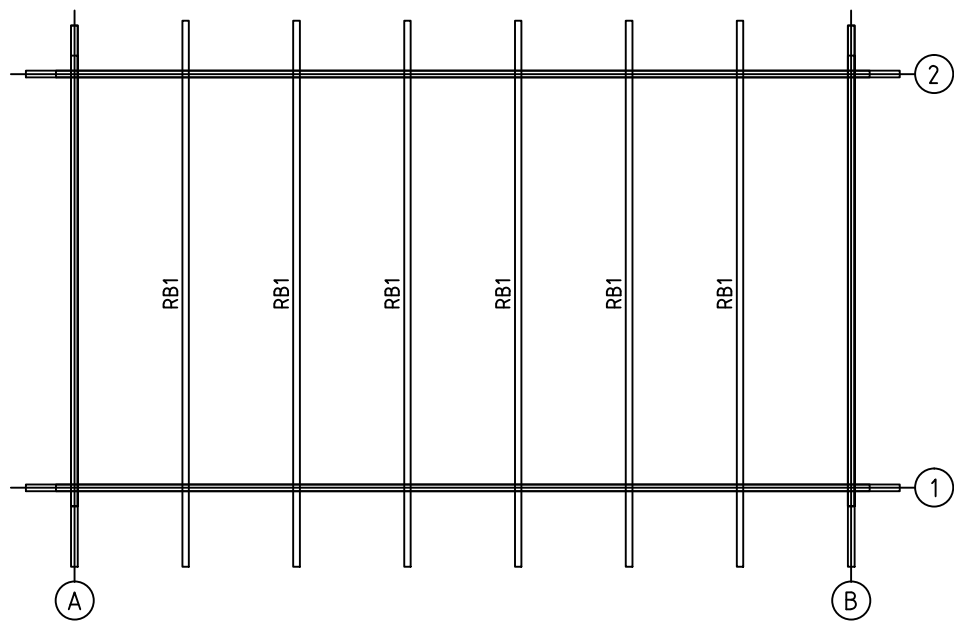

House	P5030-44 August	Sheet	6
Drawing	PURLINS-KATTO-ORRET-TAKÅSAR	Scale	1:50
Material	43x140	Date	12.02.2016
Drawer	RP	File	P5030-44 August.dwg

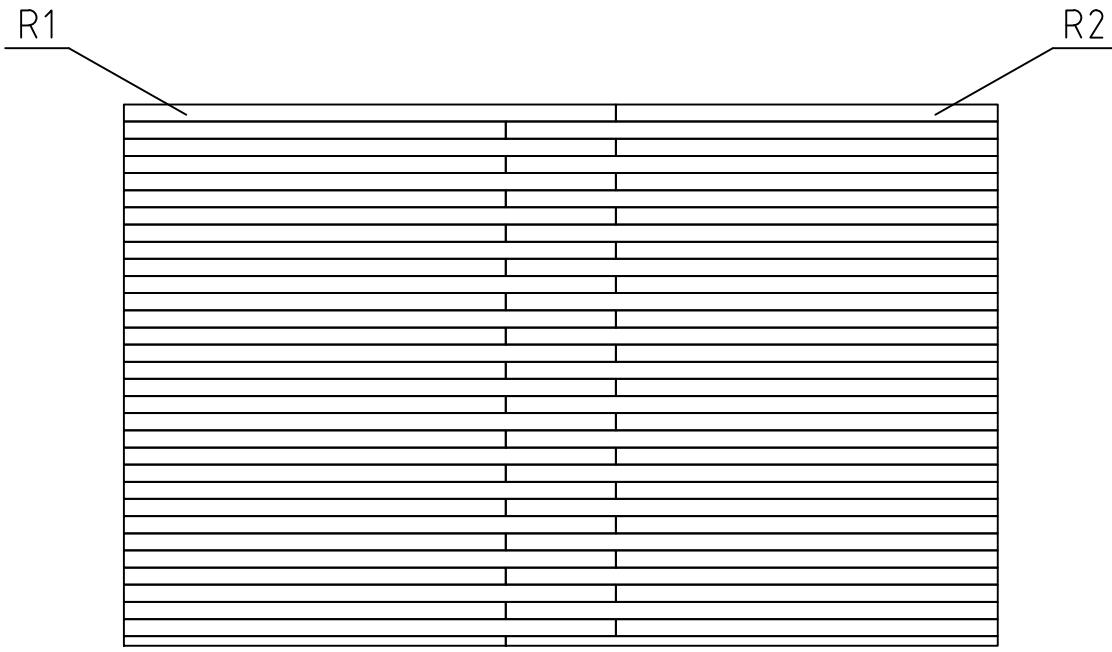

House	P5030-44 August	Sheet	7
Drawing	ROOFBOARD - KATTOLAUTA - TAKBRÄDE	Scale	1:50
Material	114x19	Date	12.02.2016
Drawer	RP	File	P5030-44 August.dwg

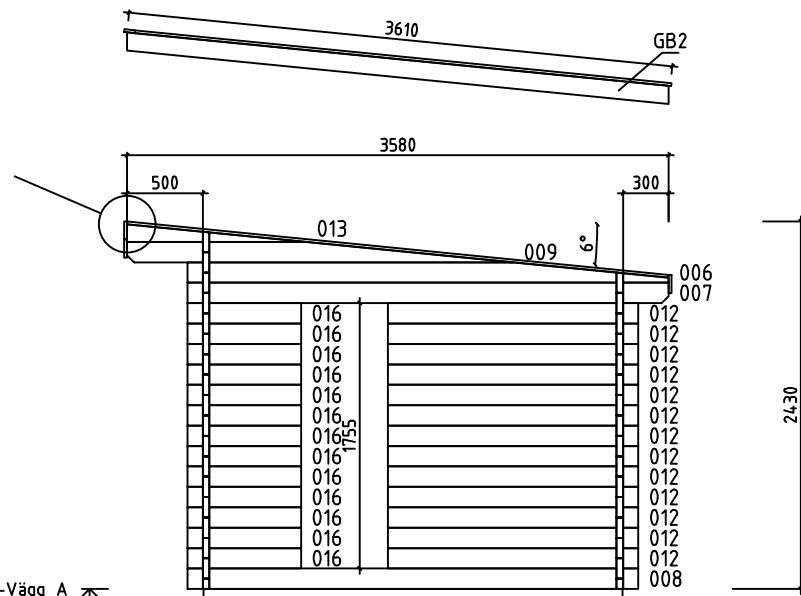
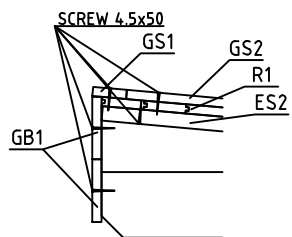

Wall-Seinä-Vägg A ↗

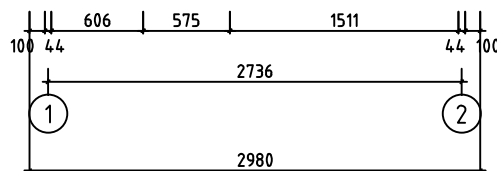

House	P5030-44 August	Sheet	8
Drawing	WALL-SEINÄ-VÄGG A	Scale	1:50
Material	44x135	Date	12.02.2016
Drawer	RP	File	P5030-44 August.dwg

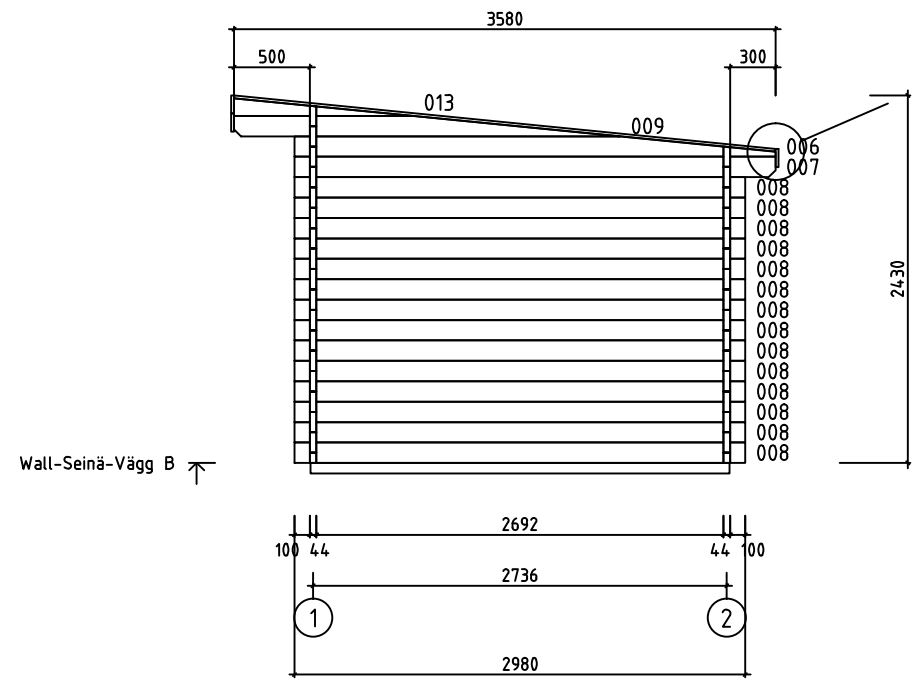
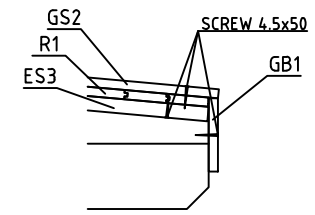

House	P5030-44 August	Sheet	9
Drawing	WALL-SEINÄ-VÄGG B	Scale	1:50
Material	44x135	Date	12.02.2016
Drawer	RP	File	P5030-44 August.dwg

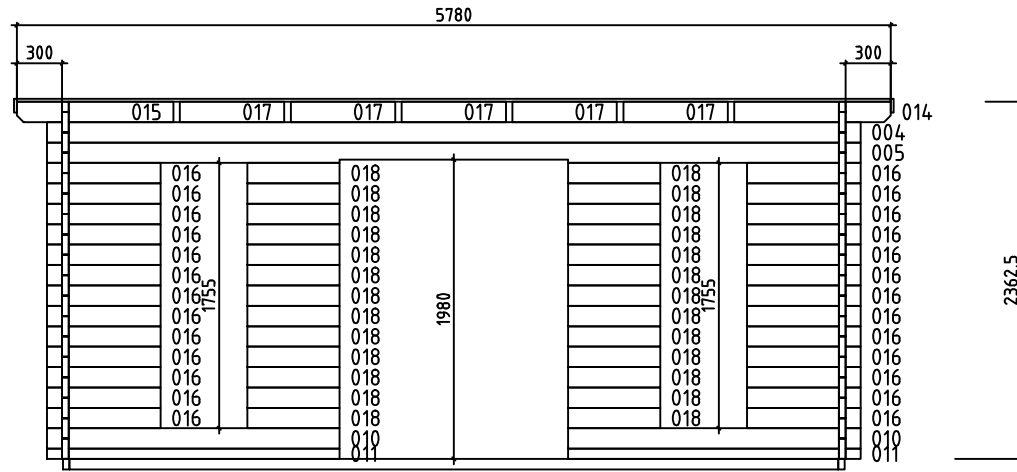
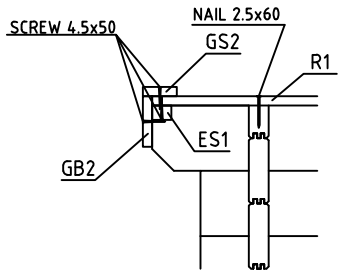



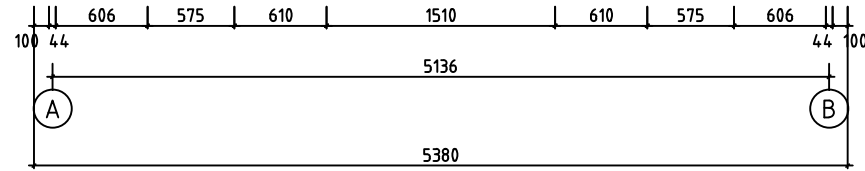



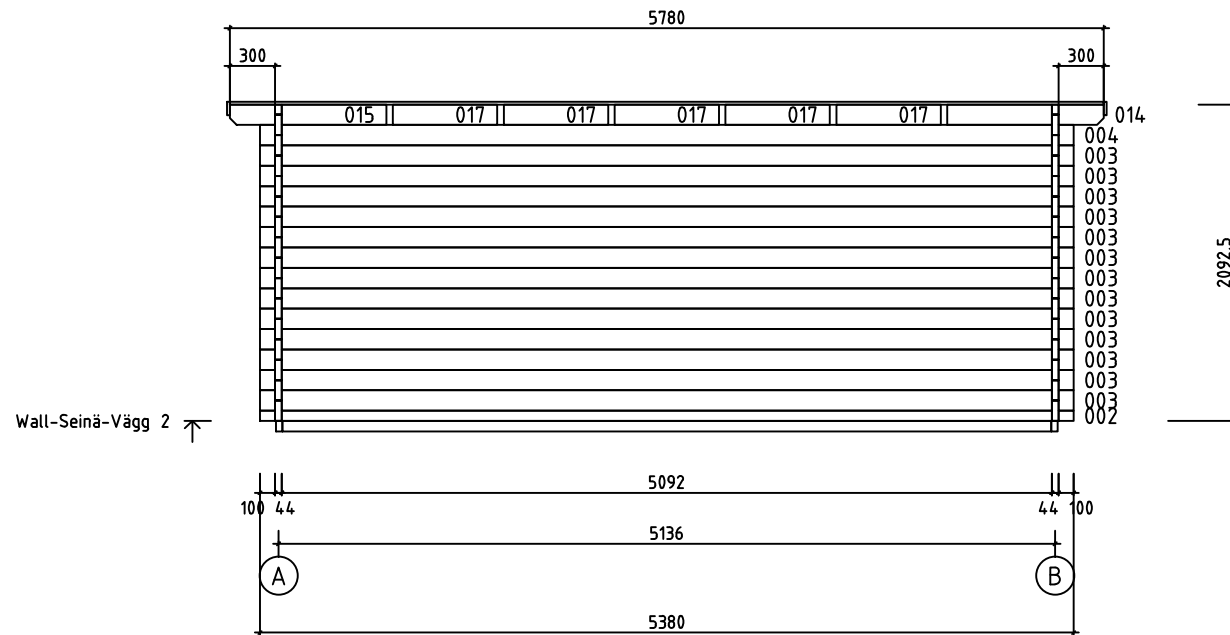

Wall- Seinä-Vägg 1 ↗

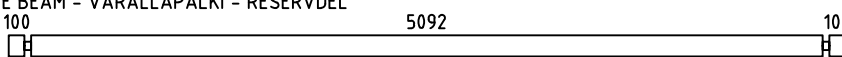
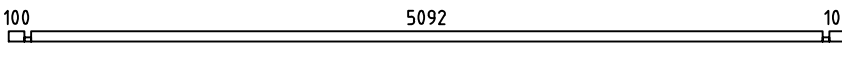
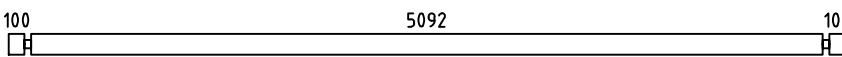
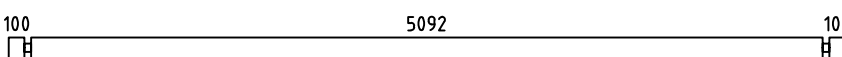
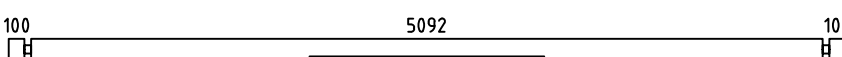
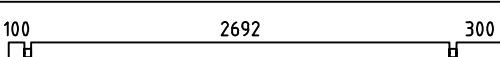
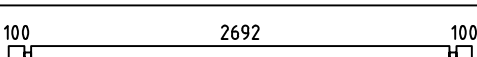
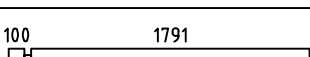
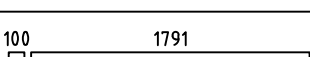
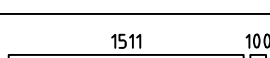
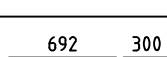
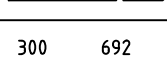
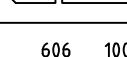
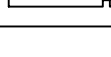

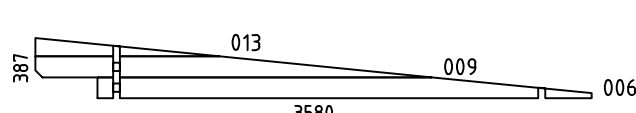

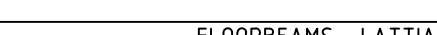
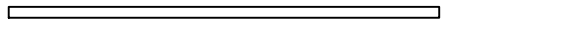





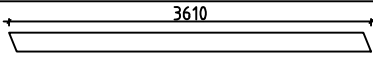









House	P5030-44 August	Sheet	10
Drawing	WALL-SEINÄ-VÄGG 1	Scale	1:50
Material	44x135	Date	12.02.2016
Drawer	RP	File	P5030-44 August.dwg

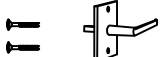
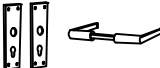

House	P5030-44 August	Sheet	11
Drawing	WALL-SEINÄ-VÄGG 2	Scale	1:50
Material	44x135	Date	12.02.2016
Drawer	RP	File	P5030-44 August.dwg

Pos	P5030-44 August	Pcs. St.	Profil(e) (mm)	L (mm)		
001	SPARE BEAM - VARALLAPALKI - RESERVDEL 	1	44x135	5380		
002		1	44x68	5380		
003		13	44x135	5380		
004		PM 2	44x135	5380		
005		1	44x135	5380		
007		2	44x135	3180		
008		15	44x135	2980		
010		2	44x135	1935		
011		2	44x68	1935		
012		13	44x135	1655		
014		2	44x135	1036		
015		2	44x135	1036		
016		39	44x135	750		
017		10	44x135	690		
018		26	44x135	610		
WA-1 WB-1		2	44x387	3580		
HB	HIT BLOCK-ASENNUSPALKI-SLAG BRÄDA 	2	44x135	300		
FB2	FLOORBEAMS - LATTIAPALKIT - GOLVBJÄLKAR 	8	43x70	5084		
FB1	FLOORBEAMS - LATTIAPALKIT - GOLVBJÄLKAR 	2	43x70	2770		
RB1	PURLINS - KATTO - ÖRRET - TAKASAR 	6	43x140	3611		
F1	FLOORBOARD - LATTIALAUTA - GOLVBRÄDE  114 or-tai-eller 88	45+1 59+1	114x19 88x19	2685		
R1	LOFT BOARD - PARVIALATTIA - LOFTGOLV  114 or-tai-eller 88	32+1 42+1	114x19 88x19	3255		
R2	ROOFBOARD - KATTOLAUTA - TAKBRÄDE  114 or-tai-eller 88	32+1 42+1	114x19 88x19	2525		
FF1	SKIRTING SLAT - LATTIALISTA - GOLVLIST 		19x35	16 m		
House	P5030-44 August	Material	File	P5030-44 August.dwg	Sheet	12

Pos	P5030-44 August	Pcs. St.	Profil(e) (mm)	L (mm)
GB1	GABLE BOARD - KAAPELILAUTA - GAVELBRÄDA 	6	19x120	2910
GB2	GABLE BOARD - KAAPELILAUTA - GAVELBRÄDA 	2	19x120	3610
GS1	BOARD MATCHING WITH GABLE BOARD-KAAPELILAUTA VASTAVA LAUTA-BRÄDA OVANPÅ GAVELBRÄDA 	2	19x70	2910
GS2	BOARD MATCHING WITH GABLE BOARD-KAAPELILAUTA VASTAVA LAUTA-BRÄDA OVANPÅ GAVELBRÄDA 	2	19x70	3565
ES1	EAVE SLAT - RÄYSTÄSLISTA - TAKFOTLIST 	2	30x40	2700
ES2	EAVE SLAT - RÄYSTÄSLISTA - TAKFOTLIST 	2	30x40	500
ES3	EAVE SLAT - RÄYSTÄSLISTA - TAKFOTLIST 	2	30x40	300
SS1	STORM SLAT-MYRSKY LISTA-OVÄDER SPJÄLA 	2	19x35	2200
SS2	STORM SLAT-MYRSKY LISTA-OVÄDER SPJÄLA 	2	19x35	1990
	SCREWS-RUUVIT-SKRUVAR FOR-VARTEN-FÖR SS1, SS2 	12	∅6	50
	WASHER-ALUSLAATTA-BRICKA FOR-VARTEN-FÖR SS1, SS2 	12	∅6	
	NAILS-NAULAT-SPIKAR FOR-VARTEN-FÖR FF1 	40	∅2.0	40
	NAILS-NAULAT-SPIKAR FOR-VARTEN-FÖR F1, R1, R2 	750	∅2.5	60
	SCREWS-RUUVIT-SKRUVAR FOR-VARTEN-FÖR GB1, GB2, GS1, GS2, ES1, ES2, ES3 	90	∅4.5	50
	SCREWS-RUUVIT-SKRUVAR FOR-VARTEN-FÖR 002, 011 FB1, FB2 	50	∅4.5	90
	SCREWS-RUUVIT-SKRUVAR FOR-VARTEN-FÖR 014, 015, 017 RB1 	40	∅6.0	160
	WINDOW HANDLE-IKKUNA KAHVA-FÖNSTER HANDTAG FOR-VARTEN-FÖR W1 	6		
	DOOR HANDLE-OVEN KAHVA-DÖRR HANDTAG FOR-VARTEN-FÖR D1 	1		
	DOOR LOCK+KEYS-OVENLUKKO+AVAIN-DÖRRLAS+NYCKLAR FOR-VARTEN-FÖR D1 	1		
	DOUBLEDOOR FRAME SET FOR-VARTEN-FÖR D1 	1		
	WINDOW WATER SILL-IKKUNALAUTA-FÖNSTERBLECK FOR-VARTEN-FÖR W1 	3		
House	P5030-44 August	Material	File	P5030-44 August.dwg
			Sheet	13

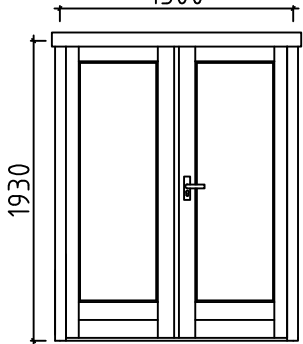
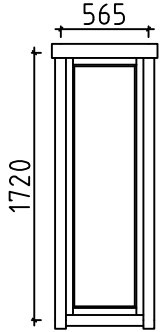
Pos	P5030-44 August	Pcs. St.	Profil(e) (mm)	L (mm)
D1	D00R-OVI-DÖRR (right-oikea-höger) ORT_ST 1500 	P	1	1500
W1	WINDOW-IKKUNAN-FÖNSTER (2x right-oikea-höger; 1x left-jäljellä-vänster) ORT_ST 565 	P+V	2+1	565
House	P5030-44 August	Material	File	P5030-44 August.dwg
			Sheet	14

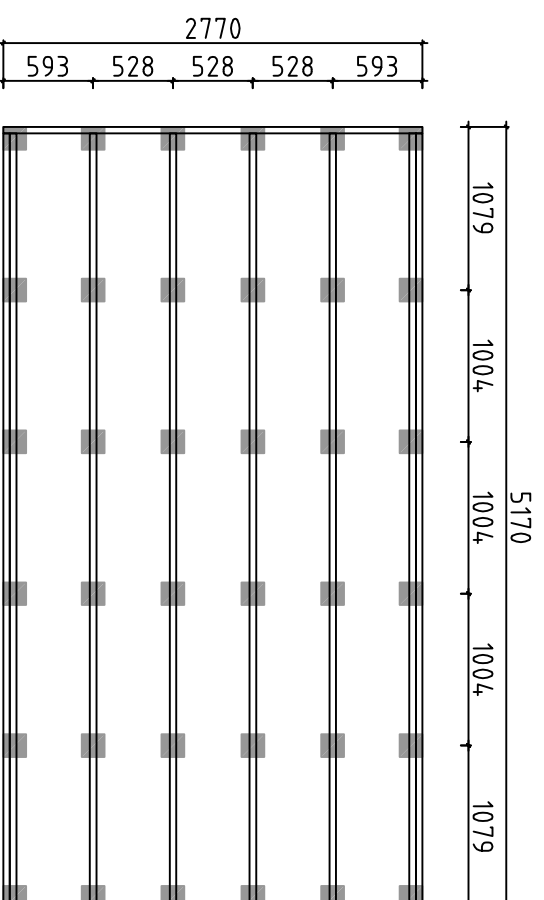

Detta är ett förslag för hur man kan placera plintarna (100-200 mm i diameter) för golvbjälklaget. Golvbjälkarna är med i byggsatsen, men inte plintarna. Använder man exempelvis 500-600mm långa murblock så kan man halvera antalet punkter. Lägg fuktskyddande papp mellan betong och trä

Tämä on ehdotus siitä, miten (100-200 mm läpimittaiset) jalat voidaan sijoittaa alapohjaa varten. Lattiapalkit ovat rakennussarjassa, mutta jalat ei ole. Kun käytetään esimerkiksi 500-600 mm pitkiä harkkoja, voidaan pisteiden määrä puoltaa. Aseta betonin ja puun väliin kosteudelta suojava pahvi

A proposal for placing plinths (100-200 mm in diameter) for floor beams. Floor beams are provided in the kit but plinths are not included. For example, by using 500-600 mm long masonry units, one can reduce the number of points 50%. Place cardboard between the concrete and wood to protect from moisture

House	P5030-44 August	Sheet	15
Drawing	FOUNDATION PLAN - PLINTPLAN	Scale	1:50
Material		Date	12.02.2016
Drawer	RP	File	P5030-44_August_Foundation.dwg

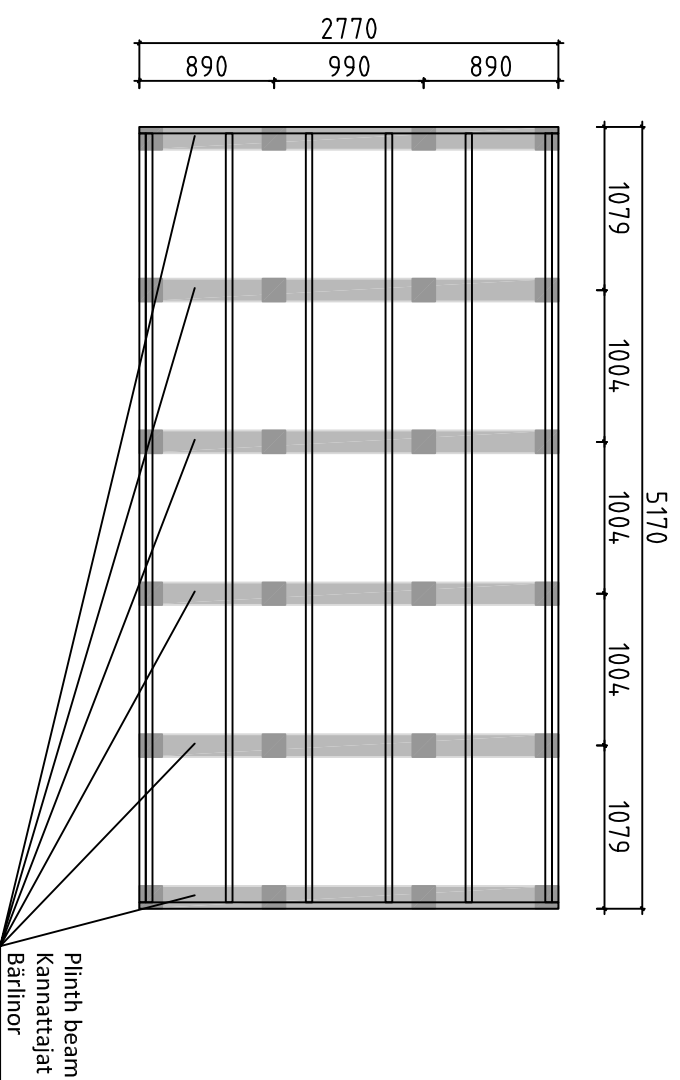

Förslag på alternativ plintplan med bärlnor och plintar. Bärlnor 45x 95 eller 45x 120 och plintar ca 100- 200 mm i diameter. (Bärlnor och plintar ingår ej i leveransen). Används exempelvis murblock, (ingår ej i leveransen) istället för plintar, kan man lägga bärlnorna platt mot dessa och på det sättet minska höjden på konstruktionen. I denna konstruktion kan man dessutom lägga en "boardskiva" mellan bärlnorna och golvbjälkarna och på det sättet bära upp bjälklagsisoleringen. Lagg fuktskyddande papp mellan betong och trä

Endotus valtoehtoisestä jalustasta kannattajilla ja jalolla. Kannattajat 45x95 tai 45x120 ja jalat läpimitään n. 100-200 mm (kannattajat ja jalat ei ole toimituksessa). Käytettäessä esimerkiksi harkkoja (ei kuulu toimitukseen) jalkojen sijasta, voi kannattajat asettaa lappeelleen niitä vasten ja sillä tavoin vähentää rakenteen korkeutta. Tässä rakenteessa voi lisäksi asettaa levyn kannattajien ja lattiapalkkien väliin ja sillä tavoin kannattaa alapohjan eristystä. Aseta betonin ja puun väliin kosteudelta suojaava pähvi

A proposal for alternative plinth beam layout plan. Plinth beams 45x95 or 45x120 and plinths ca 100-200 mm in diameter (plinth beams and plinths are not included in the kit). For example, by using masonry units (not included in the kit) instead of plinths, one can lay plinth beams flat against the masonry units and in that way reduce the height of the structure. In this construction one can also add "plywood board" between plinth beams. Place cardboard between the concrete and wood to protect from moisture

House	P5030-44 August	Sheet	16	
Drawing	FOUNDATION PLAN - PLINTPLAN		Scale	1:50
Material		Date	12.02.2016	
Drawer	RP	File	P5030-44_August_Foundation.dwg	

#001		5380	1
#002	2	5380	1
#003	2	5380	13
#004	1,2	5380	2
#005	1	5380	1
#006	A,B	3180	2
#007	A,B	3180	2
#008	A,B	2980	15
#009	A,B	2552	2
#010	1	1935	2
#011	1	1935	2
#012	A	1655	13
#013	A,B	1184	2
#014	1,2	1036	2
#015	1,2	1036	2
#016	1,A	750	39
#017	1,2	690	10
#018	1	610	26